

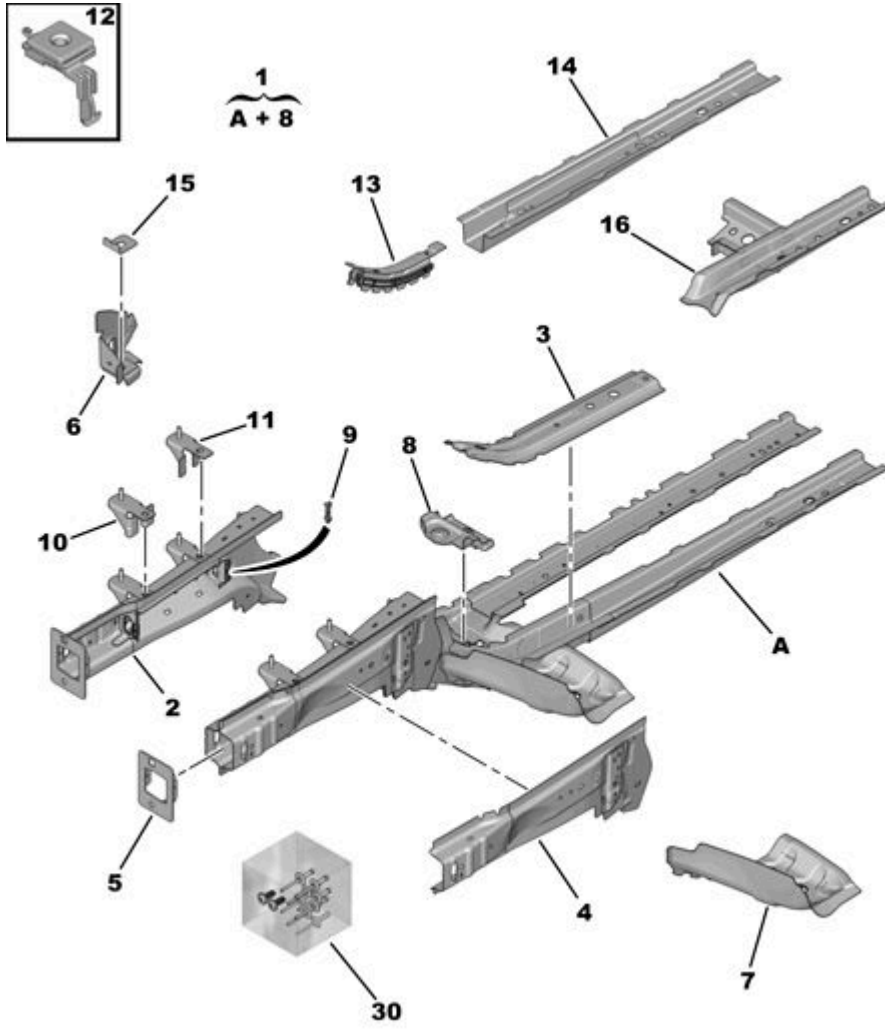







23.03.2022 741301A ÖN ŞAŞI KOLU



04/2023

00122032

01	16 173 058 80	REACH	01	ÖN ŞAŞI KOLU SAĞ ASS	
	16 173 061 80	REACH	01	SOL ASS	
02	16 090 045 80	REACH	01	ÖN ŞAŞI KOLU SAĞ PREPARE	
	16 173 056 80 RP 16 310 640 80	REACH	01 01	SOL PREPARE	
03	98 069 105 80	REACH	01	ARKA TABAN SACI TAKVİYESİ SAĞ	
	RP 98 381 836 80 98 069 106 80	REACH	01 01	SOL	
04	98 130 322 80	REACH	01	ÖN ŞAŞI KOLU TABANI SAĞ	
	RP 98 279 049 80 98 130 323 80	REACH	01 01	ASS SOL ASS	
05	96 783 208 80	REACH	01	TAMPON DARBE EMİCİ DESTEĞİ SAĞ AV ASS	
	96 783 209 80	REACH	01	SOL AV ASS	
06	16 090 089 80	REACH	01	MOTOR BEŞİĞİ TSPT DSTK SAĞ AV ASS	
	16 090 090 80	REACH	01	SOL AV ASS	
07	96 888 236 80	REACH	01	KISA ŞAŞI KOLU BAĞLANTISI SAĞ	
	RP 16 807 300 80 96 888 240 80	REACH	01 01	SOL	
08	96 759 794 80	REACH	01	MOTOR SALINCAĞI BAĞL TAKVİYESİ SAĞ	
	RP 98 276 983 80 96 759 795 80	REACH	01 01	ASS SOL	
	RP 98 276 984 80	REACH	01	ASS	
09	98 181 398 80	REACH	02	YAPISAL ARA PARÇASI DROIT OU GAUCHE	
10	96 743 847 80	REACH	01	VİTES KUTUSU MESNEDİ AV	
11	96 743 846 80	REACH	01	VİTES KUTUSU MESNEDİ AR	
12	96 763 795 80	REACH	02	KASA BAĞLANTI SOMUNU M14X200	
15	98 008 554 80	REACH	01	MOTOR SALINCAĞI BAĞL TAKVİYESİ AV 1609008980 VE 1609009080 ÜZERİNE TAKILACAK	
30	16 742 323 80	REACH	01	(MKT) ÖN DARBE TSP MLZ	